

COLOR CODED ASSEMBLY INSTRUCTIONS

ASSEMBLY
INSTRUCTIONS

FUTON FRAME BIFOLD BODY DECKS (6 SLATS)

Instructions apply to sizes:
Full





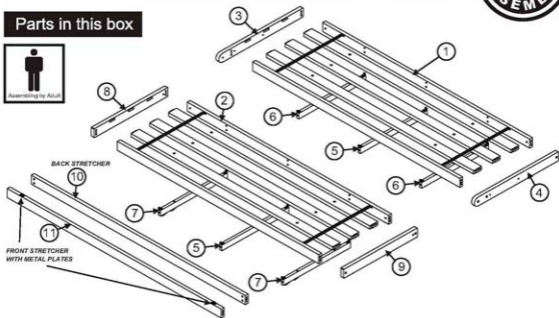





Parts in this box



- | | | | |
|--------------------------|-------|---|-------|
| ① BACK DECK BUNDLE | 1 SET | ⑦ SLAT SUPPORT WITH HOLE AND PLASTIC STOPPERS | 2 PCS |
| ② SEAT DECK BUNDLE | 1 SET | ⑧ LEFT SEAT SIDE RAIL | 1 PC |
| ③ LEFT BACK SIDE RAIL | 1 PC | ⑨ RIGHT SEAT SIDE RAIL | 1 PC |
| ④ RIGHT BACK SIDE RAIL | 1 PC | ⑩ BACK STRETCHER | 1 PC |
| ⑤ SLAT SUPPORT | 2 PCS | ⑪ FRONT STRETCHER WITH METAL PLATES | 1 PC |
| ⑥ SLAT SUPPORT WITH HOLE | 2 PCS | | |

Hardware in this box

- | | | | |
|--|--|---|--|
| 
A 60mm Bolts - 8 pcs | 
D Barrel Nuts - 8 pcs | 
G Roller - 4 pcs Complete with Clevis pin, Washer and Locking pin. | 
H Clevis pin - 2 pcs with Washer and Locking pin. |
| 
B 35mm Bolts - 12 pcs | 
E Wooden Dowels - 4 pcs | | |
| 
C 16mm Bolts - 12 pcs | 
F Wood buttons - 4 pcs | | 
I Allen Key - 1 pc |

Install all Wooden dowels (E) to the Front Stretcher and Back Stretcher.

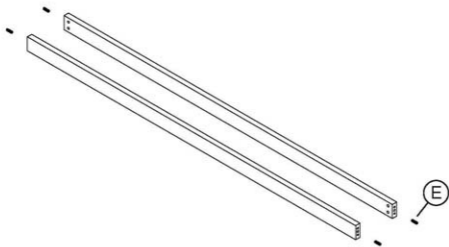

Fit the slat support (5)(6) to the back deck (1). Using Bolts (C)(B) tighten with allen key (I). The back deck bundle is longer than the seat bundle. Identify the correct slat supports as shown below, and fit under the slats. Do not fully tighten any of the bolts yet!

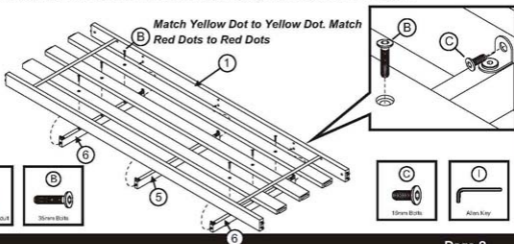

Fit the Rollers (G) to the back side rails (3)(4).

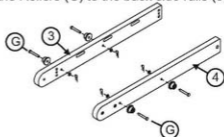

Assemble the side rails (3)(4) to the back deck, using Bolts (A) and Barrel Nuts (D). Tighten with Allen key (I).

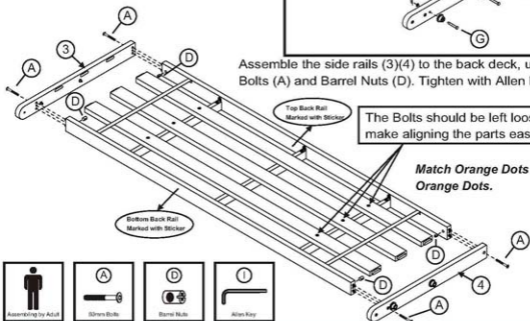

Only when all the parts are correctly in place, should you tighten all the Bolts. Finally fit the two wood buttons (F).

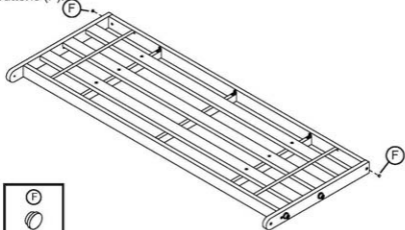

Fit the slat support (5)(7) to the seat deck bundle(2). Using Bolts(C)(B) tighten with allen key (I)
The seat deck bundle is shorter than the seat. Identify the correct slat supports as shown below, and fit under the slats. Do not fully tighten any of the bolts yet!

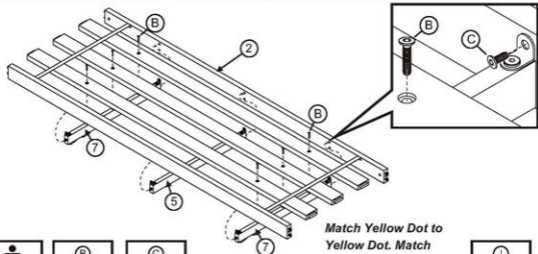

Match Yellow Dot to Yellow Dot. Match Green Dots to Green Dots.

Assemble the side rails (8)(9) to the seat deck, using Bolts (A) and Barrel Nuts (D). Tighten with Allen key (I).

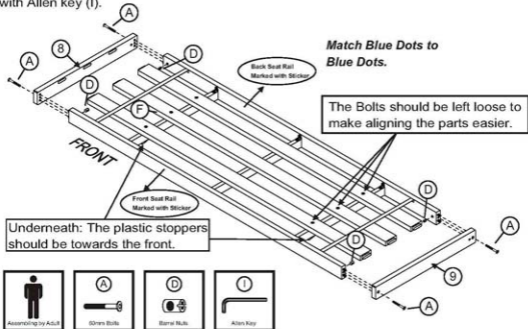

Match Blue Dots to Blue Dots.

The Bolts should be left loose to make aligning the parts easier.

Underneath: The plastic stoppers should be towards the front.

Only when all the parts are correctly in place, should you tighten all the Bolts. Finally fit the two wood buttons (F).

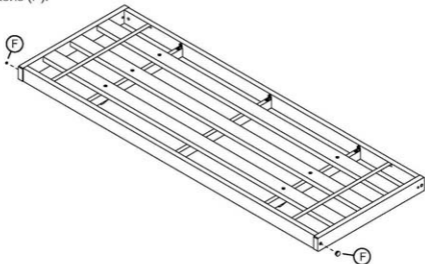

Using Clevis assemblies (H), Connect Seat and back deck as show

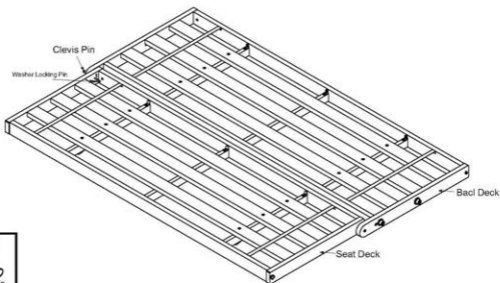

"GO TO ASSEMBLY INSTRUCTIONS IN FUTON ARM BOX TO COMPLETE ASSEMBLY".